

Keerwand element langs strandafgang, kleur lichtblauw

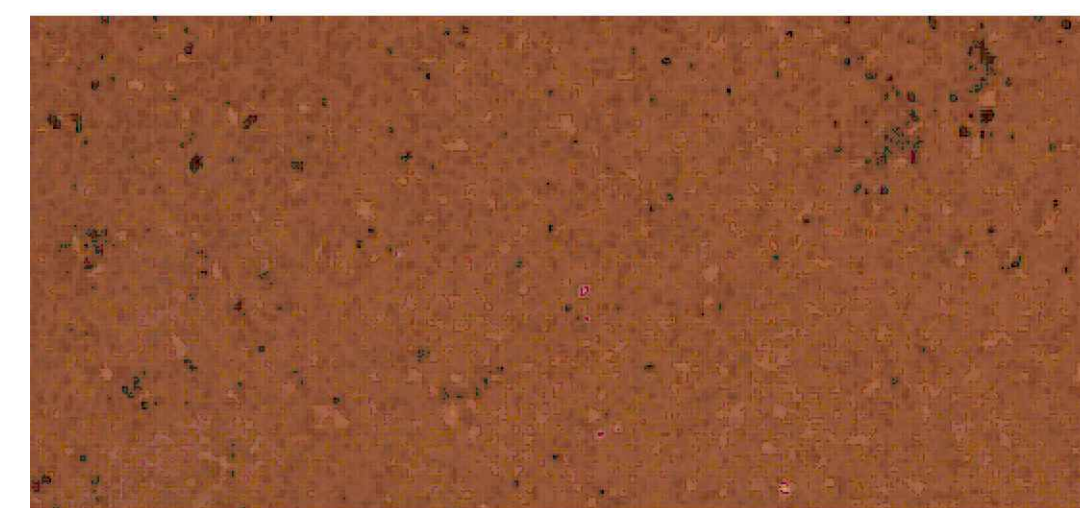

standaard terra  
Kleur banken "standaard terra" Struyk Verwo

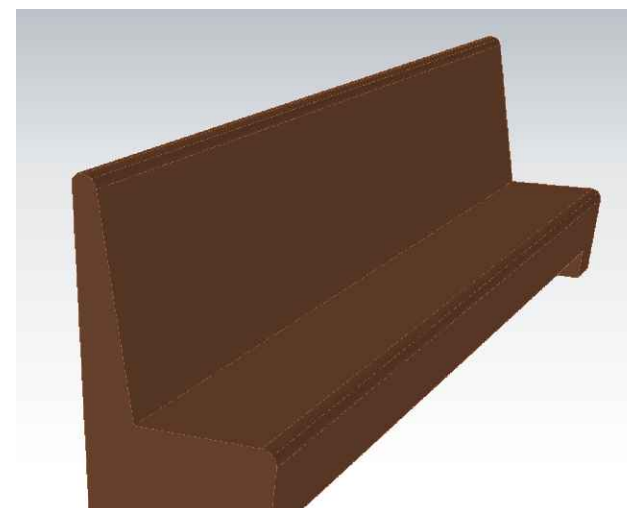

Betonnen bank met rugleuning  
Kleur banden Struyk Verwo Drain wit

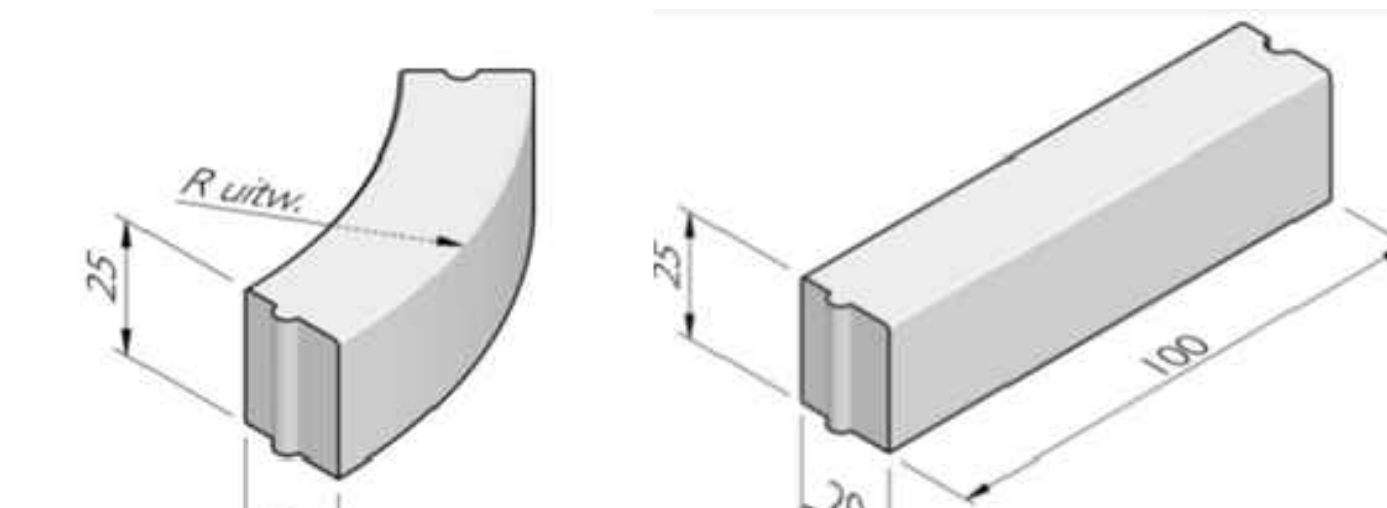
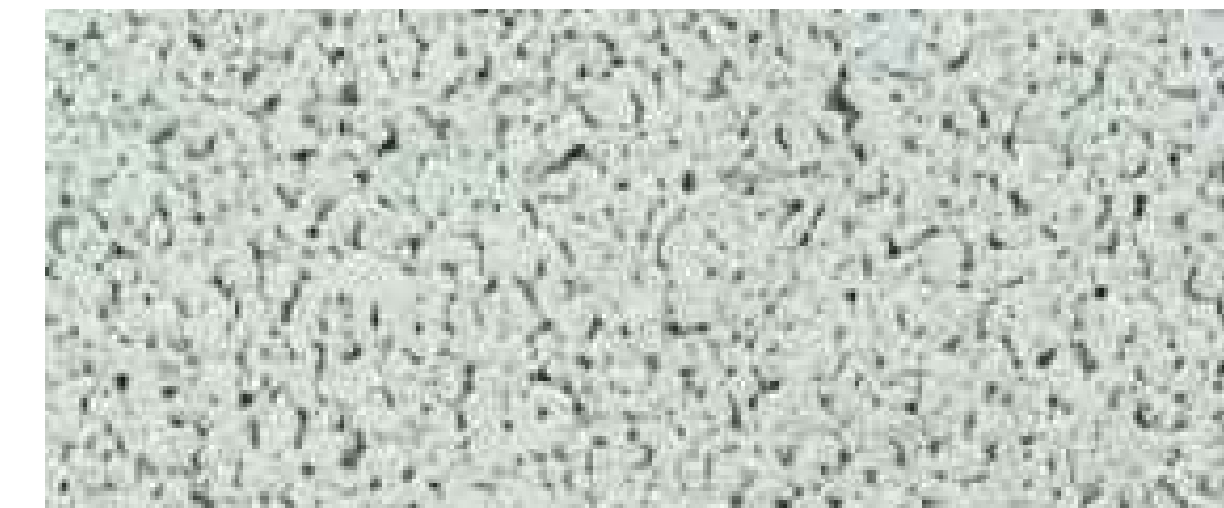

Struyk Verwo opsluitbanden rijloper



Bestrating rijloper

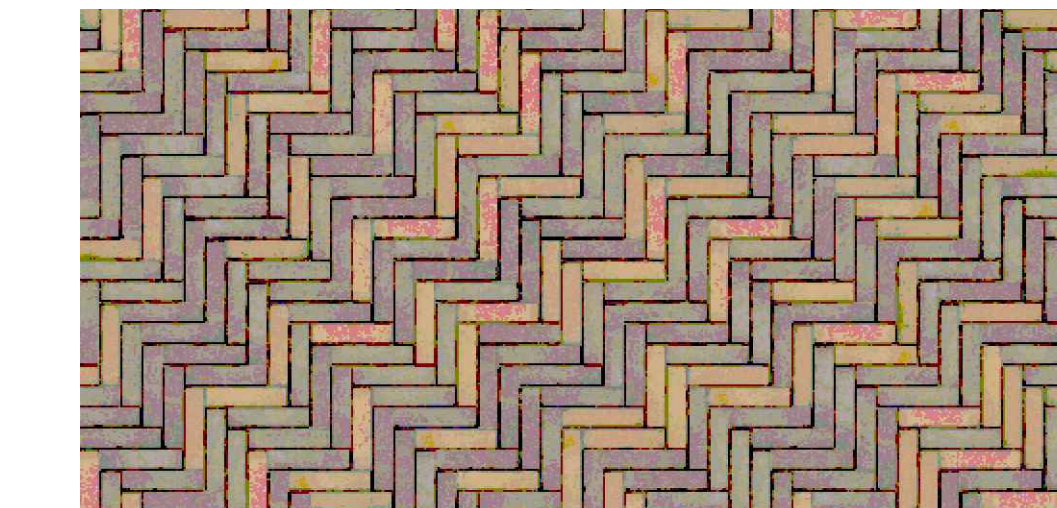

Bestrating plein



Van Moortel  
gebakken stenen



Schetsontwerp Blinkers



Rolcontainers



Watertappunt, zonnebrand en infopaneel



Kastanjehouten hekwerk



Monument

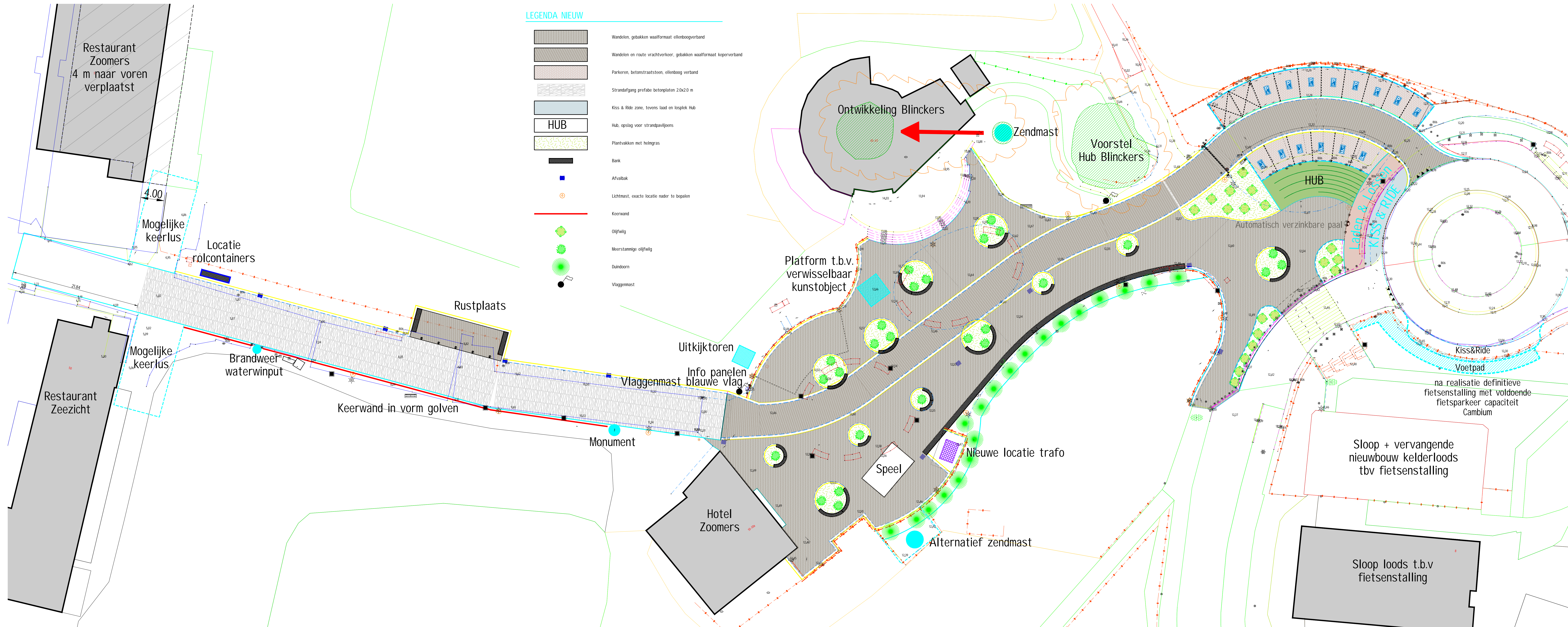

Voorbeeld tijdelijk kunstwerk

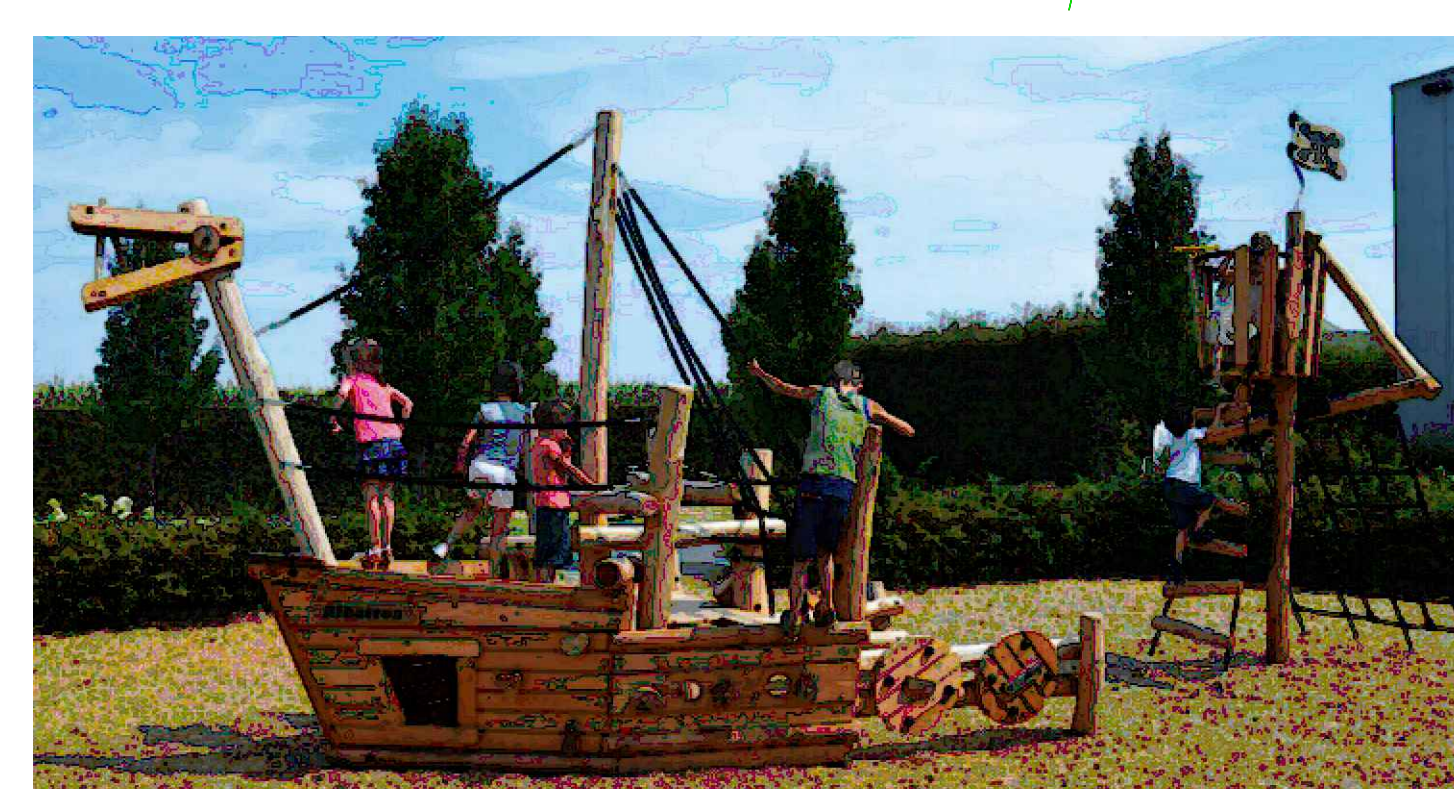

Speeltoestel



Afvalbak, kleur nader te bepalen



Lichtmast Accoya hout



Armatuur strandafgang



Armatuur plateau



Plantvak met bank en meerstammige olijfwilg en helmgras



Meerstammige olijfwilg



Erdi verzinkbare paal



Sicuro uitkijktoren 500

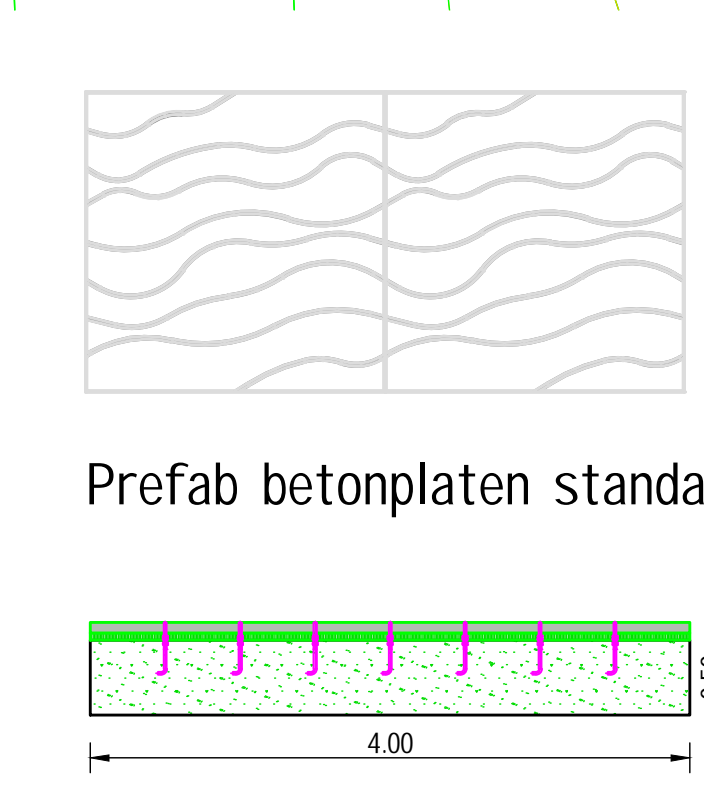

Prefab betonplaten strandafgang

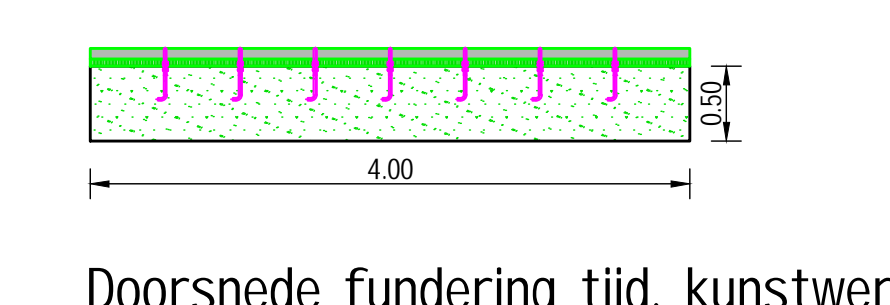

Doorsnede fundering tijd. kunstwerk

Opdrachtgever: **de BUCH**

Projectnaam: **Strandafgang Castricum aan Zee**

Omschrijving: **Voorlopig ontwerp**

Schaal: 1:200

Opsteller: VO

Ontwerper: JHS

Projectnummer: 2023-006

01 van 01

de BUCH

JHS

© 2023 de BUCH